



AF-250 DMX
fog machine

Musikhaus Thomann e.K.

Treppendorf 30

96138 Burgebrach

Germany

Telephone: +49 (0) 9546 9223-0

E-mail: info@thomann.de

Internet: www.thomann.de

31.10.2014, ID: 340945

Table of contents

1	General notes	5
	1.1 Further information.....	6
	1.2 Notational conventions.....	7
	1.3 Symbols and signal words.....	8
2	Safety instructions	11
3	Features	17
4	Installation	18
5	Starting up	20
6	Connections and operating elements	22
7	Operating	30
	7.1 Remote control functions.....	32
	7.2 DMX control.....	33
8	Technical specifications	34
9	Plug and connection assignments	36

10	Troubleshooting.....	37
11	Cleaning.....	39
12	Protecting the environment.....	41

1 General notes

This manual contains important instructions for the safe operation of the unit. Read and follow the safety instructions and all other instructions. Keep the manual for future reference. Make sure that it is available to all those using the device. If you sell the unit please make sure that the buyer also receives this manual.

Our products are subject to a process of continuous development. Thus, they are subject to change.

1.1 Further information

On our website (www.thomann.de) you will find lots of further information and details on the following points:

Download	This manual is also available as PDF file for you to download.
Keyword search	Use the search function in the electronic version to find the topics of interest for you quickly.
Online guides	Our online guides provide detailed information on technical basics and terms.
Personal consultation	For personal consultation please contact our technical hotline.
Service	If you have any problems with the device the customer service will gladly assist you.

1.2 Notational conventions

This manual uses the following notational conventions:

Letterings

The letterings for connectors and controls are marked by square brackets and italics.

Examples: *[VOLUME]* control, *[Mono]* button.

Displays

Texts and values displayed on the device are marked by quotation marks and italics.

Examples: *'24ch'*, *'OFF'*.

Instructions

The individual steps of an instruction are numbered consecutively. The result of a step is indented and highlighted by an arrow.





Example:

1. ▶ Switch on the device.
2. ▶ Press *[Auto]*.
 - ⇒ Automatic operation is started.
3. ▶ Switch off the device.

1.3 Symbols and signal words

In this section you will find an overview of the meaning of symbols and signal words that are used in this manual.

Signal word	Meaning
DANGER!	This combination of symbol and signal word indicates an immediate dangerous situation that will result in death or serious injury if it is not avoided.
WARNING!	This combination of symbol and signal word indicates a possible dangerous situation that can result in death or serious injury if it is not avoided.
CAUTION!	This combination of symbol and signal word indicates a possible dangerous situation that can result in minor injury if it is not avoided.
NOTICE!	This combination of symbol and signal word indicates a possible dangerous situation that can result in material and environmental damage if it is not avoided.
Warning signs	Type of danger
	Warning – high-voltage.

Warning signs	Type of danger
	Warning – flammable substances.
	Warning – hot surface.
	Warning – suspended load.
	Warning – harmful or irritating substances.
	Warning – danger zone.

2 Safety instructions

Intended use

This device is intended to be used to produce artificial fog by vaporising fog fluid. Use the device only as described in this user manual. Any other use or use under other operating conditions is considered to be improper and may result in personal injury or property damage. No liability will be assumed for damages resulting from improper use.

This device may be used only by persons with sufficient physical, sensorial, and intellectual abilities and having corresponding knowledge and experience. Other persons may use this device only if they are supervised or instructed by a person who is responsible for their safety.

Safety



DANGER!

Danger for children

Ensure that plastic bags, packaging, etc. are disposed of properly and are not within reach of babies and young children. Choking hazard!

Ensure that children do not detach any small parts (e.g. knobs or the like) from the unit. They could swallow the pieces and choke!

Never let children unattended use electrical devices.



DANGER!

Electric shock caused by high voltages inside

Within the device there are areas where high voltages may be present. Never remove any covers.

There are no user-serviceable parts inside.



DANGER!

Electric shock caused by short-circuit

Do not modify the mains cable or the plug. Failure to do so could result in electric shock/death or fire. If in doubt, seek advice from a registered electrician.



WARNING!

Risk of burns from flammable liquids

The use of flammable liquids in this device may cause severe burns and damage to property.

Always use approved fog fluids. Never fill flammable liquids into the tank of the device.



WARNING!

Risk of burns

The generated fog at the fog nozzle is hot and can cause burns. Occasionally hot fluid drops may escape from the nozzle.

The distance of persons and objects to the fog nozzle must be at least fifty centimetre (1.6 feet).

Do not touch the fog nozzle during and shortly after operation. It becomes very hot and may cause burns even several hours after switching off the device.



WARNING!

Risk of slipping caused by condensation

Fog machines can produce condensation. Do not direct the fog to floors. Floors and surfaces can become slippery by condensed fog.

Check at regular intervals whether it is possible to walk on the floors without a slipping hazard, and, if necessary, remove the condensation.



WARNING!

Health hazard caused by fog fluid handling

Fog fluid does contain glycols complying with the regulations for foodstuffs. However, it may be harmful if swallowed.

Do not induce vomiting. Seek medical advice immediately. Keep fog fluid in a safe place. If the fog fluid comes into contact with eyes rinse thoroughly with water.



CAUTION!

Possible respiratory problems

The device can be operated safely only with the approved fog fluid. The use of other fluids can release toxic gases. Claims for damages caused by the use of non-approved fluids shall be excluded.

Do not create fog in closed or poorly ventilated areas.

Do not expose persons with health problems (such as allergic respiratory conditions, asthma) to artificial fog.



NOTICE!

Risk of fire

Do not cover the device nor any ventilation slots. Do not place the device near any direct heat source. Keep the device away from naked flames.



NOTICE!

Operating conditions

This device has been designed for indoor use only. To prevent damage, never expose the device to any liquid or moisture. Avoid direct sunlight, heavy dirt, and strong vibrations.



NOTICE!

Power supply

Before connecting the device, ensure that the input voltage (AC outlet) matches the voltage rating of the device and that the AC outlet is protected by a residual current circuit breaker. Failure to do so could result in damage to the device and possibly injure the user.

Unplug the device before electrical storms occur and when it is unused for long periods of time to reduce the risk of electric shock or fire.

3 Features

This fog machine is suitable for use in clubs, bars, discotheques and on stages

Special features of the device:

- Superior performance by highly efficient heating element
- Control via DMX (one channel) or via the supplied remote control
- Suitable for mobile use due to compact design
- Bracket for mounting on truss or ceiling included

4 Installation

Unpack and carefully check that there is no transportation damage before using the unit. Keep the equipment packaging. To fully protect the device against vibration, dust and moisture during transportation or storage use the original packaging or your own packaging material suitable for transport or storage, respectively.



WARNING!

Risk of injury caused by falling objects

Make sure that the installation complies with the standards and rules that apply in your country. Always secure the device with a secondary safety attachment, such as a safety cable or a safety chain.

Mounting options

You can install the unit in hanging or standing position. The unit should be installed horizontally, deviations of maximum 15° are allowed. The device requires 20 cm clearance at the sides and above. During use, the device must always be attached to a solid surface or to a approved truss. Use the openings provided on the bracket for attaching.

Always work from a stable platform whenever installing, moving or servicing the unit. In doing so, the area underneath the unit must be cordoned off.

The safety-rope must be attached to the bracket.

5 Starting up

Establish all connections as long as the unit is switched off. Use the shortest possible high-quality cables for all connections.



NOTICE!

Possible data transmission errors

For error-free operation make use of dedicated DMX cables and do not use ordinary microphone cables.

Never connect the DMX input or output to audio devices such as mixers or amplifiers.

Connections in DMX mode

Connect the DMX input of the device to the DMX output of a DMX controller or another DMX device. Connect the output of the first DMX device to the input of the second one, and so on to form a daisy chain. Always ensure that the output of the last DMX device in the daisy chain is terminated with a resistor ($110\ \Omega$, $\frac{1}{4}\ \text{W}$).

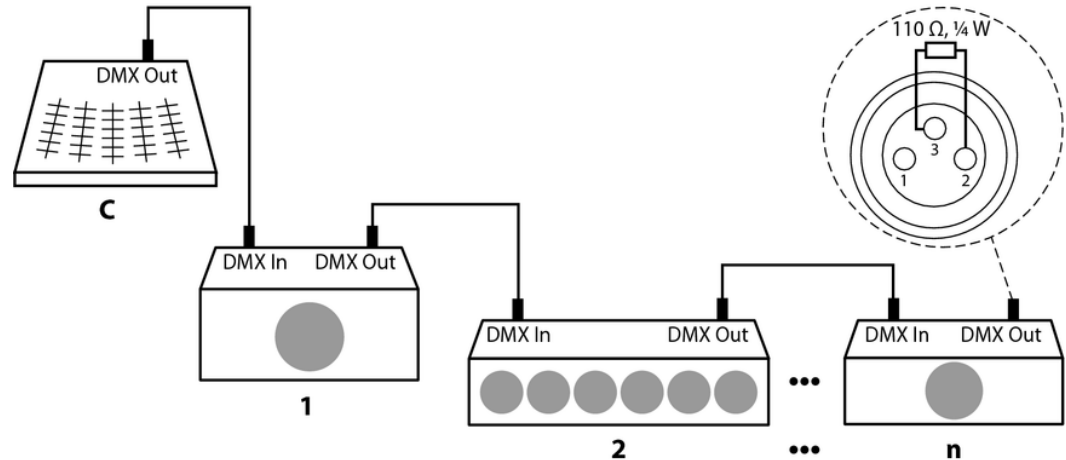

6 Connections and operating elements

Front panel

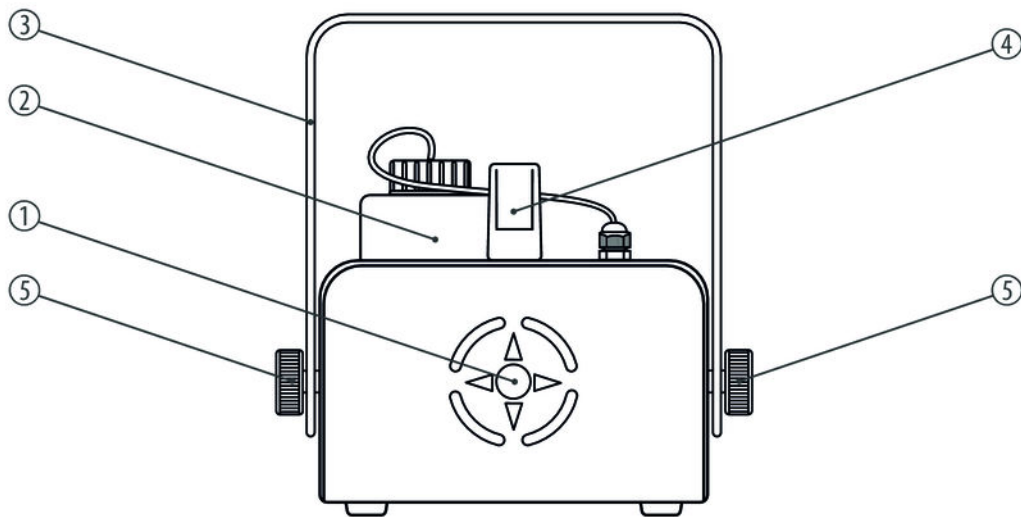

1	Fog nozzle.
2	Fog fluid container with screw-cap.
3	Bracket for hanging.
4	Carrying handle.
5	Locking screws for the mounting bracket.

Rear panel

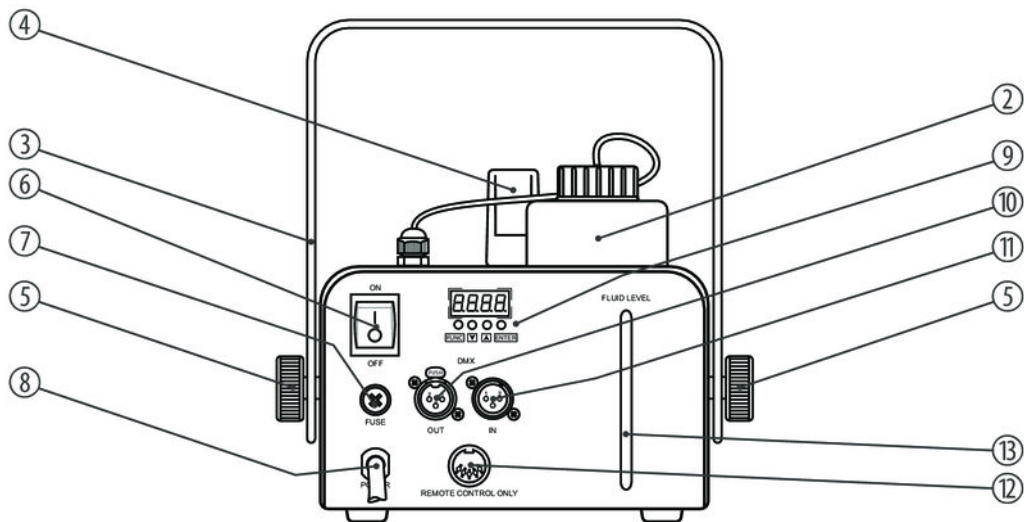

2	Fog fluid container with screw-cap.
3	Bracket for hanging.
4	Carrying handle.
5	Locking screws for the mounting bracket.
6	Main switch. Turns the device on and off.
7	<i>[FUSE]</i> Fuse holder.
8	Mains cable for power supply.
9	Display with control buttons:
	<i>[ENTER]</i> Button to select a menu option and to confirm the entered values.
	▲ Key to page down in the menu system, and to increase the displayed value.

	▼ Key to page up in the menu system, and to decrease the displayed value.
	<i>[FUNC]</i> Button to open the control menu.
10	<i>[DMX OUT]</i> DMX output.
11	<i>[DMX IN]</i> DMX input.
12	<i>[REMOTE CONTROL ONLY]</i> Connection for the remote control.
13	Liquid level indicator.

Remote control

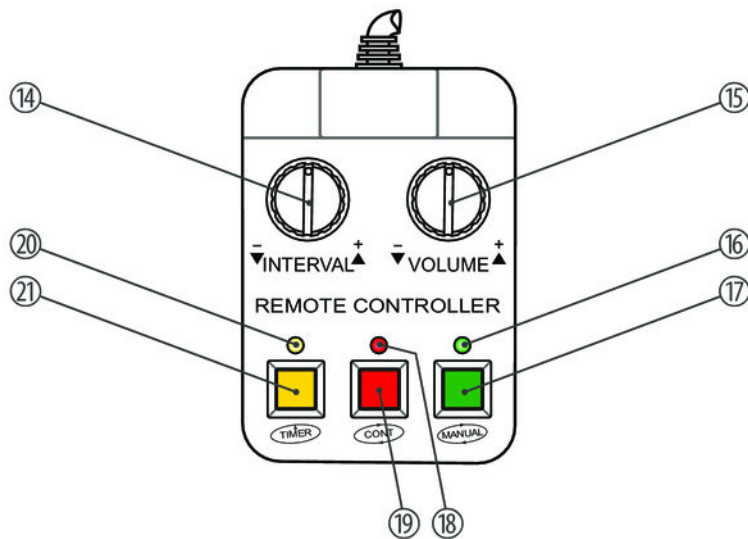

AF-250 DMX

14	Rotary control <i>[INTERVAL]</i> With this control you can set the time interval between two fog outputs in a range between 10 and 200 seconds.
15	Rotary control <i>[VOLUME]</i> With this control you can adjust the amount of fog to be produced by the device with each blast (between 0 % and 100 %).
16	The green LED indicates that the unit has reached the operating temperature necessary to produce fog.
17	Pushbutton <i>[MANUAL]</i> Push this button for maximum fog output regardless of other settings.
18	The red LED indicates that continuous operation is turned on.
19	Pushbutton <i>[CONT]</i> Press this switch to turn continuous operation on or off. In this mode, the fog volume you have set with the <i>[VOLUME]</i> control is continuously emitted.

20 The yellow LED indicates that the Timer function is turned on.

21 Pushbutton *[TIMER]*

With this switch, you can turn the Timer function on or off. In this mode, the amount of fog set by the *[VOLUME]* control is emitted within the time intervals that you have set with the *[INTERVAL]* control.

7 Operating

Filling the unit



NOTICE!

Possible damages caused by unsuitable fog fluid

Fog fluids not approved by the manufacturer may permanently damage the unit.

Exclusively use the fog fluids specified in chapter 'Technical specifications' of this manual and follow its instructions for use.

First, make sure the unit is disconnected from the mains.

Open the screw-cap of the liquid container and fill in the fog fluid. Make sure that no fluid is spilled or gets into the device. The easiest way is using a funnel. The container capacity is 1.9 litre.

Screw the cap firmly back on.

Turning the unit on



NOTICE!

Fire hazard

Do not operate the machine unattended.

Make sure that the remote control is connected.

Connect the device to the mains and switch it on with the main switch. During heating, the display shows the value 'UP'.

As soon as the required operating temperature is reached, the green LED on the remote lights up and the display shows the set DMX address. The device is now operational.

Operation

When operating, always ensure that there is sufficient fog fluid in the liquid container to avoid no-load running.

Turning the unit off

Disconnect the device from the mains. Transport the device only when it is completely cooled down. To avoid leaking fog fluid during transport, you should transport the device only with empty fluid container.

7.1 Remote control functions

When the device is not controlled by DMX, it supports the following operating modes that can be selected with the remote control:

- Manual operation with maximum fog
Press the pushbutton *[MANUAL]*. This mode takes precedence over all others. This means that you don't have to stop the timer function and continuous operation before you press the button.
- Continuous operation with adjustable amount of fog
In this mode, the fog volume you have set with the *[VOLUME]* control is continuously emitted. Press the *[CONT]* switch to turn the operating mode on or off.
- Timer-controlled operation with adjustable amount of fog
In this mode, the amount of fog set by the *[VOLUME]* control is emitted at regular intervals (adjustable with the *[INTERVAL]* control). Press the *[TIMER]* switch to turn the operating mode on or off. The yellow LED indicates that the Timer function is enabled. Each fog burst lasts about three seconds.

7.2 DMX control

DMX address assignment

Turn the unit on as described above. Use the arrow buttons ▼ and ▲ to assign the desired DMX address in a range from 1 ... 512. Confirm the selection with *[ENTER]*. You can then control the device with a connected controller.

DMX assignment

Channel	Value	Function
1	Setting the amount of fog	
	0...255	No fog output (0 %) to maximum fog output (100 %)

8 Technical specifications

Approved fog fluids	Stairville FAST-FOG
	Stairville E-Fluid
	Stairville E-C-Fluid
	Stairville E-M-Fluid
	Stairville E-HD-Heavy-Fluid
Heater power	1300 W
Fog output	approx. 180 m ³ /min
Blast distance	approx. 4 ... 5 m
Fluid consumption	approx. 86 ml / min
Fluid container capacity	1.9 l
Warm-up time	approx. 5 min
Operating supply voltage	230 V ~ (AC), 50 Hz

Fuse	5 A / 250 V, slow-blow, 5 mm × 20 mm
Power consumption	1300 W
Dimensions (W × H × D)	310 mm × 190 mm × 430 mm
Weight	7.1 kg

9 Plug and connection assignments

Introduction

This chapter will help you select the right cables and plugs to connect your valuable equipment so that a perfect light experience is guaranteed.

Please take our tips, because especially in 'Sound & Light' caution is indicated: Even if a plug fits into a socket, the result of an incorrect connection may be a destroyed DMX controller, a short circuit or 'just' a not working light show!

DMX connections

The unit offers a 3-pin XLR socket for DMX output and a 3-pin XLR plug for DMX input. Please refer to the drawing and table below for the pin assignment of a suitable XLR plug.



Pin	Configuration
1	Ground, shielding
2	Signal inverted (DMX-, 'cold signal')
3	Signal (DMX+, 'hot signal')

10 Troubleshooting

In the following we list a few common problems that may occur during operation. We give you some suggestions for easy troubleshooting:

Symptom	Remedy
The unit does not work	Check the mains connection and the main fuse.
No haze output	<ol style="list-style-type: none"> 1. Check the fluid level in the fog container. 2. Switch the device off and check the hose that leads into the fluid container for flow.
No response to the DMX controller	<ol style="list-style-type: none"> 1. Check the address settings and the DMX polarity. 2. Try using another DMX controller. 3. Check to see if the DMX cables run near or alongside to high voltage cables that may cause damage or interference to DMX interface circuits.

If the procedures recommended above do not succeed, please contact our Service Center. You can find the contact information at www.thomann.de.

11 Cleaning



NOTICE!

Possible damages caused by unsuitable cleaning agents

Cleaners not approved by the manufacturer may permanently damage the unit.

Only use the fog machine cleaners listed on www.thomann.de and follow their instructions for use.

Clean the appliance after every 30 operating hours, or if it was not in use for a longer period of time.

Procedure

1. ➤ Make sure that the device is turned off, disconnected from the mains and completely cooled down.
2. ➤ Place the unit in a well ventilated place.
3. ➤ Take the suction hose out of the fluid container of the fog machine and put it into the bottle with the cleaning fluid.
4. ➤ Connect the device to the mains and turn it on with the main switch.
5. ➤ Wait until the required operating temperature has been reached.

- 6.** ▶ Switch the unit to continuous operation and release fog for about 20 seconds.
- 7.** ▶ Put the suction hose back into the fluid container of the fog machine and release fog for another 20 seconds. This rinses the pipes.
 - ⇒ The cleaning is completed.

12 Protecting the environment

Disposal of the packaging material



For the transport and protective packaging, environmentally friendly materials have been chosen that can be supplied to normal recycling.

Ensure that plastic bags, packaging, etc. are properly disposed of.

Do not just dispose of these materials with your normal household waste, but make sure that they are collected for recycling. Please follow the notes and markings on the packaging.

Disposal of your old device



This product is subject to the European Waste Electrical and Electronic Equipment Directive (WEEE). Do not dispose with your normal household waste.

Dispose of this device through an approved waste disposal firm or through your local waste facility. When discarding the device, comply with the rules and regulations that apply in your country. If in doubt, consult your local waste disposal facility.



